



Warranty Information

JANDON faucet warrants the original purchase (must have prove of purchase) that such product is free from defect in materials or workmanship for as long as the original consumer purchaser owns their home from the date of purchase. This warranty is limited to but not including labor charges incurred and/or damages sustained during installation, repair or replacement, nor incidental or consequential damages. This warranty does not cover items which have received secondary finishing or have been altered or modified after purchase, or for defects caused by physical abuse to or misuse of the product. This warranty gives the original purchaser of a JANDON faucet specific legal rights which may vary from state to state or from province to province. In some states or provinces the exclusion or limitation of incidental or consequential damages is not allowed, so those exclusions may not apply to you.

Thank you for your purchase !

JANDON® FAUCETS
Useful Everyday

Toll Free : 1 - 877 - 526 - 3668
Website : www.jandonfaucet.com
E - mail : info@jandonfaucet.com

JANDON® FAUCETS
Useful Everyday

Model : 8209 Series

Chrome, Brushed Nickel PVD, Oil Rubbed Bronze



5pc Roman Tub With Hand-held Shower

- 2. Handle Installation** ② ③
- A. Underside the deck, insert stem body, attach with handle flange, insert handle on the top of stem, adjust handle pointing position, screw tighten from top, replace handle cap, tighten with mount nut and nut screws from underside of deck.
- B. Assemble outlet connector with flat rubber gasket.
- 1. Spout Installation** ①
- A. Position spout on deck, from underside of deck, assemble "rubber & metal washer", tighten with mount nut and nut screws.

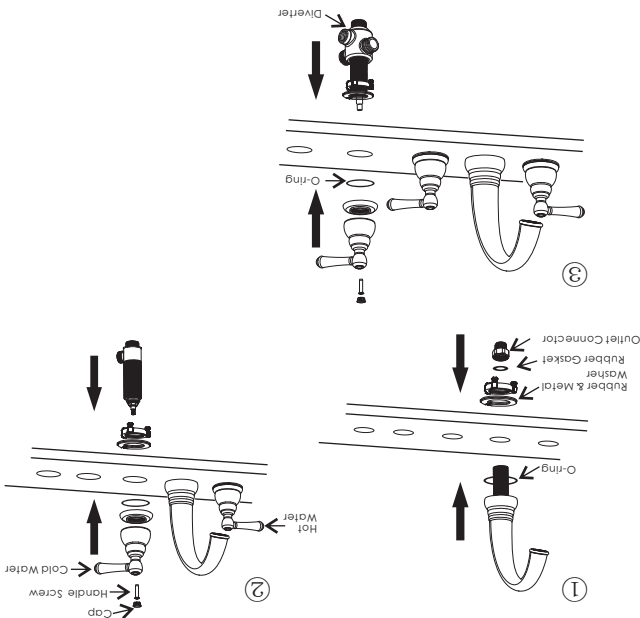

Spout & Handle Installation

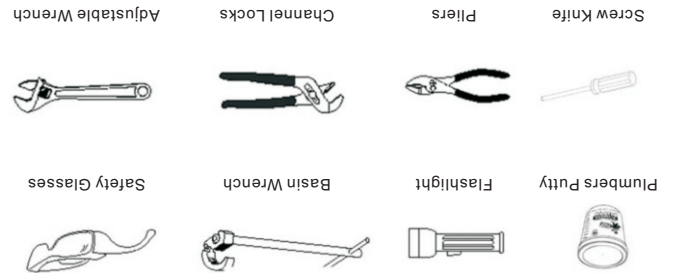

Gather the necessary tools as shown below to complete the installation of this faucet. Some may not be needed depending on the model of faucet you are installing. Check with your local hardware store on the requirements of your installation situation.

Helpful Tools

Helpful Information



2

Hand-held Shower Base Installation

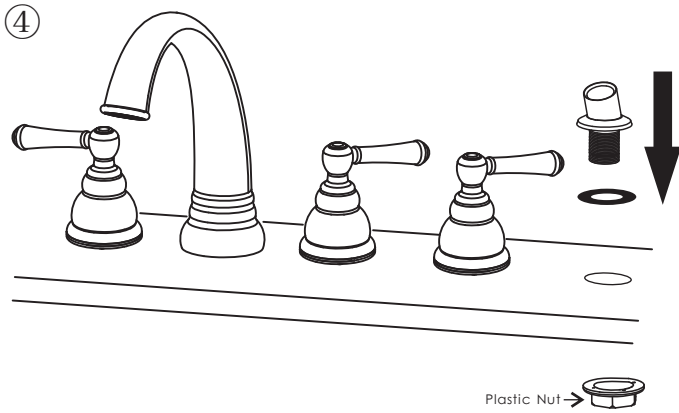

1. Hand-held shower base installation ④

A. Insert hand-held shower hose assembly to far right hole on deck, hand tighten with nut from underneath.

4



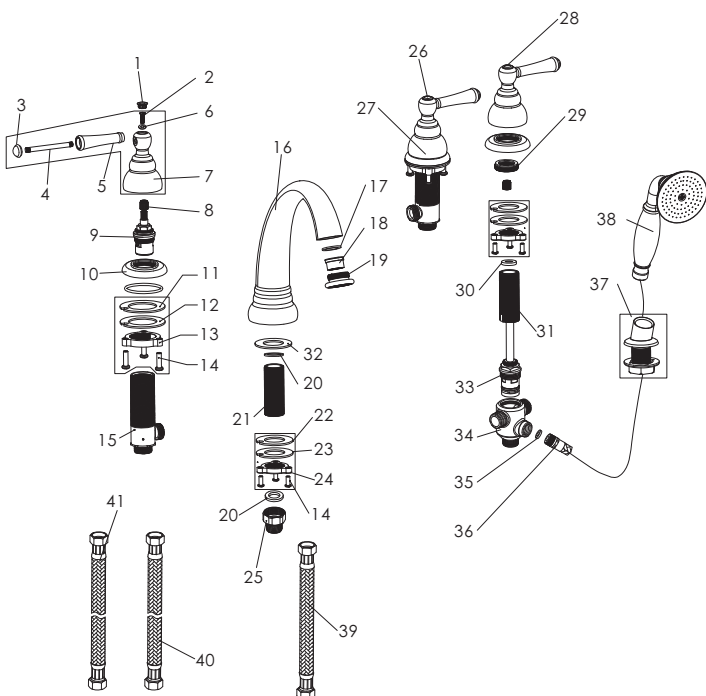

Parts Diagram

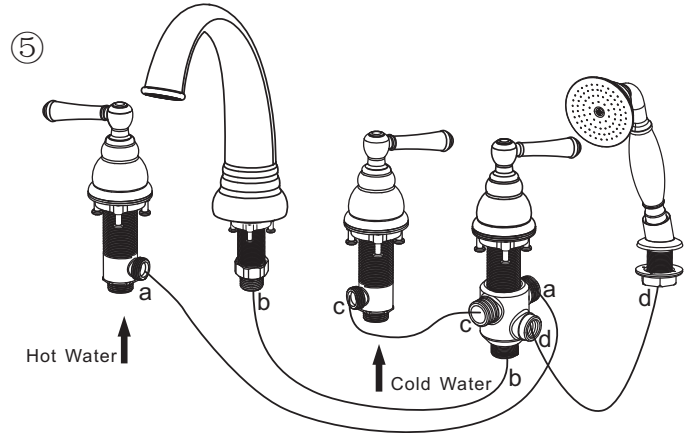

3

Hose Installation



- a  31¹/₂" (800 mm)
- b  23⁵/₈" (600 mm)
- c  15³/₄" (400 mm)
- d  86" (2185 mm)

1. Hose Installation ⑤

A. Insert hand-held shower and hose through and connect with faucet diverter underside deck and tighten.
 B. Connect all stainless steel braided hoses according to ⑤ with tools.

★ Run water through faucet while checking for leaks at all connections.

5

Parts List

41	G028051	G1/2, 600mm Hose
40	G026051	G1/2, 800mm Hose
39	G024051	G1/2, 400mm Hose
38	F1386	Hand-held Shower
37	80D99RMO	Base
36	H28226	Shower Hose
35	8J14X7X3	O-Ring
34	80T94018	Diverter Housing
33	K20B16902	Distribute Ceramic Cartridge
32	8J49X33X2	O-Ring
31	81T28226	Coop
30	8J195X33X2	Ring For Fixing Cartridge
29	8JT8000	Handle Connector
28	80N82H80	Cap
27	K28226B	Ceramic Cartridge (For Hot Water)
26	80N82H8C	Cap
25	8JT26A1	Diverter
24	8NM94015	Nut
23	80N94015	Metal Washer
22	81N94015	Rubber Washer
21	82G0Y961	Screw Coop
20	8J24X15X3	Rubber Gasket
19	80M28226	Aerator Assembly Insert
18	8NM94015	Aerator Assembly Housing
17	8J255X195X3	Flat Rubber Washer
16	80G28226A	Spout
15	80T94017	Hose Kit
14	8RM6X15	Screw
13	82N56U26	Nut
12	80N56U16	Metal Washer
11	81N56U26	Rubber Washer
10	83P24Y82	Handle Base
9	K28226A	Ceramic Cartridge (For Cold Water)
8	81P24T42	Screw Assembly
7	80P24Y82	Handle Base
6	8TD9X4X08	Handle Screw
5	81P24Y82	Handle
4	8BM6X74	Screw
3	82P24Y81	Screw Assembly
2	8RM4X15	Handle Screw
1	80N82H8H	Cap
No.	Part Number	Part Name